

EON ONE MK2

User's Guide

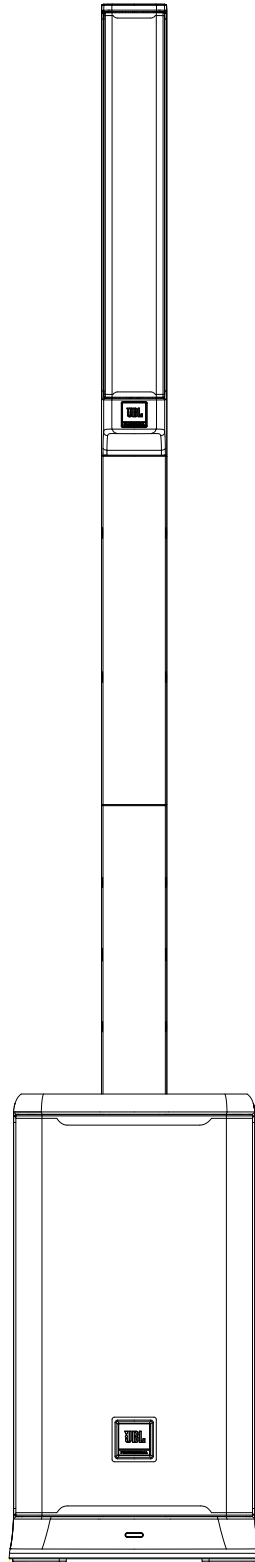

CONTENTS

Safety Instructions	4
Precautions.....	6
Declaration of Conformity.....	7
Intro to EON ONE MK2	8
Block Diagram	10
Application Examples	11
Mixer Panel.....	14
Mixer Panel Functions	15
EasyNav LCD	18
App.....	28
Optional Accessories.....	29
EON ONE MK2 Specifications	30
Cables & Connectors.....	31
Contact Information	32
Warranty Information	33

SAFETY INSTRUCTIONS



The EON ONE MK2 system covered by this manual is not intended for use in high moisture environments. Moisture can damage the speaker cone and surround and cause corrosion of electrical contacts and metal parts. Avoid exposing the speakers to direct moisture. Keep speakers out of extended or intense direct sunlight. The driver suspension will prematurely dry out and finished surfaces may be degraded by long-term exposure to intense ultra-violet (UV) light. The EON ONE MK2 system can generate considerable energy. When placed on a slippery surface such as polished wood or linoleum, the speaker may move due to its acoustical energy output. Precautions should be taken to assure that the speaker does not fall off a stage or table on which it is placed.

HEARING DAMAGE, PROLONGED EXPOSURE TO EXCESSIVE SPL

The EON ONE MK2 system is capable of generating sound pressure levels (SPL) sufficient to cause permanent hearing damage to performers, production crew, and audience members. Caution should be taken to avoid prolonged exposure to SPL in excess of 85 dB.

CARE & CLEANING

EON ONE MK2 systems may be cleaned with a dry cloth. Do not allow moisture into any of the openings in the system. Ensure that the system is unplugged from the AC outlet before cleaning.

THIS APPARATUS CONTAINS POTENTIALLY LETHAL VOLTAGES. TO PREVENT ELECTRIC SHOCK OR HAZARD, DO NOT REMOVE CHASSIS, MIXER MODULE, OR AC INPUT COVERS. NO USER SERVICEABLE PARTS INSIDE. REFER SERVICING TO QUALIFIED SERVICE PERSONNEL.

WEEE Notice

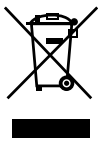

The Directive 2012/19/EU on Waste Electrical and Electronic Equipment (WEEE), which entered into force as European law on 14/02/2014, resulted in a major change in the treatment of electrical equipment at end-of-life.

The purpose of this Directive is, as a first priority, the prevention of WEEE, and in addition, to promote the reuse, recycling and other forms of recovery of such wastes so as to reduce disposal. The WEEE logo on the product or on its box indicating collection for electrical and electronic equipment consists of the crossed-out wheeled bin, as shown below.

This product must not be disposed of or dumped with your other household waste. You are liable to dispose of all your electronic or electrical waste equipment by relocating over to the specified collection point for recycling of such hazardous waste. Isolated collection and proper recovery of your electronic and electrical waste equipment at the time of disposal will allow us to help conserving natural resources. Moreover, proper recycling of the electronic and electrical waste equipment will ensure safety of human health and environment. For more information about electronic and electrical waste equipment disposal, recovery, and collection points, please contact your local city center, household waste disposal service, shop from where you purchased the equipment, or manufacturer of the equipment.

RoHS Compliance

This product is in compliance with Directive 2011/65/EU and (EU) 2015/863 of the European Parliament and of the Council of 19. 31/03/2015 on the restriction of the use of certain hazardous substances in electrical and electronic equipment.

REACH

REACH (Regulation No 1907/2006) addresses the production and use of chemical substances and their potential impacts on human health and the environment. Article 33 (1) of REACH Regulation requires suppliers to inform the recipients if an article contains more than 0.1% (per weight per article) of any substance(s) on the Substances of Very High Concern (SVHC) Candidate List ('REACH candidate list').

This product contains the substance "lead" (CAS-No. 7439-92-1) in a concentration of more than 0.1% per weight.

At the time of release of this product, except for the lead substance, no other substances of REACH candidate list are contained in a concentration of more than 0.1% per weight in this product.

Note: on June 27, 2018, lead was added to the REACH candidate list. The inclusion of lead in the REACH candidate list does not mean that lead-containing materials pose an immediate risk or results in a restriction of permissibility of its use.

-
1. READ these instructions.
 2. KEEP these instructions.
 3. HEED all warnings.
 4. FOLLOW all instructions.
 5. DO NOT use this apparatus near water.
 6. CLEAN ONLY with dry cloth.
 7. DO NOT block any ventilation openings. Install in accordance with the manufacturer's instructions.
 8. DO NOT install near any heat sources such as radiators, heat registers, stoves, or other apparatus (including amplifiers) that produce heat.
 9. DO NOT defeat the safety purpose of the polarized or grounding type plug. A polarized plug has two blades with one wider than the other. A grounding type plug has two blades and a third grounding prong. The wider blade or the third prong are provided for your safety. If the provided plug does not fit into your outlet, consult an electrician for replacement of the obsolete outlet.
 10. PROTECT the power cord from being walked on or pinched, particularly at plugs, convenience receptacles, and the point where they exit from the apparatus.
 11. ONLY USE attachments/accessories specified by the manufacturer.
 12.  USE ONLY with a cart, stand, tripod, bracket, or table specified by the manufacture, or sold with the apparatus. When a cart is used, use caution when moving the cart/apparatus combination to avoid injury from tip-over.
 13. UNPLUG this apparatus during lightning storms or when unused for long periods of time.
 14. REFER all servicing to a qualified service personnel. Servicing is required when the apparatus has been damaged in any way, such as power-supply cord or plug is damaged, liquid has been spilled or objects have fallen into the apparatus, the apparatus has been exposed to rain or moisture, does not operate normally, or has been dropped.
 15. DO NOT expose this apparatus to dripping or splashing and ensure that no objects filled with liquids, such as vases, are placed on the apparatus.
 16. To completely disconnect this apparatus from the AC Mains, disconnect the power supply cord plug from the AC receptacle.
 17. Where the mains plug or an appliance coupler is used as the disconnect device, the disconnect device shall remain readily operable.
 18. DO NOT overload wall outlets or extension cords beyond their rated capacity as this can cause electric shock or fire.
 19. For adequate ventilation, do not install this equipment in a confident or enclosed space, such as a book case or similar unit. Product ventilation should not be impeded by covering the ventilation openings with items such as newspaper, tablecloths, curtains, etc.



The exclamation point, within an equilateral triangle, is intended to alert the user to the presence of important operating and maintenance (servicing) instructions in the literature accompanying the product.



The lightning flash with an arrowhead symbol within an equilateral triangle is intended to alert the user to the presence of uninsulated "dangerous voltage" within the product's enclosure that may be sufficient in magnitude to constitute a risk of electrical shock to persons.

WARNING: To reduce the risk of fire or electrical shock, do not expose this apparatus to rain or moisture.

WARNING: No naked flame sources – such as lighted candles –should be placed on the product.

WARNING: Equipment shall be connected to a MAINS socket outlet with a protective earthing connection.

PRECAUTIONS

WARNING: This product is intended to be operated ONLY from the voltages listed on the back panel. Operation from other voltages other than those indicated may cause irreversible damage to the product and void the product's warranty. The use of AC Plug Adapters is cautioned because it can allow the product to be plugged into voltages in which the product was not designed to operate. If you are unsure of the correct operational voltage, please contact your local distributor and/or retailer. If the product is equipped with a detachable power cord, use only the type provided, or specified, by the manufacturer or your local distributor.

OPERATING TEMPERATURE RANGE: -20°C - 40°C (-4°F - 104°F)



WARNING: Do Not Open! Risk of Electrical Shock. Voltages in this equipment are hazardous to life. No user-serviceable parts inside. Refer all servicing to qualified service personnel.

Place the equipment near a main power supply outlet and make sure that you can easily access the power breaker switch.

WARNING: Batteries (battery pack or batteries installed) shall not be exposed to excessive heat such as sunshine, fire or the like.

CAUTION: Danger of explosion if battery is incorrectly replaced. Replace only with the same or equivalent type. Please dispose of any used batteries properly, following any local regulations. Do not incinerate..

WARNING: DO NOT EXPOSE BATTERIES OR BATTERY PACK TO EXCESSIVE HEAT, SUCH AS THAT FROM OPEN FLAMES, DIRECT SUNSHINE, ETC.

CAUTION: DANGER OF EXPLOSION IF BATTERY IS INCORRECTLY REPLACED, REPLACE ONLY WITH THE SAME OR EQUIVALENT TYPE.

DO NOT UNDER ANY CIRCUMSTANCES OPERATE THE UNIT WITH THE WRONG VOLTAGE SELECTED. DOING SO MAY RESULT IN SERIOUS DAMAGE TO YOUR PA SYSTEM WHICH WILL NOT BE COVERED BY WARRANTY.

FCC AND CANADA EMC COMPLIANCE INFORMATION: This device complies with Part 15 of the FCC Rules. Operation is subject to the following two conditions

1. This device may not cause harmful interference, and (2) this device must accept any interference received, including interference that may cause undesired operation.

CAUTION: Changes or modifications not expressly approved by the manufacturer could void the user's authority to operate this device.

NOTE: This equipment has been tested and found to comply with the limits for a Class B digital device, pursuant to Part 15 of the FCC Rules. These limits are designed to provide reasonable protection against harmful interference in a residential installation. This equipment generates uses and can radiate radio frequency energy and, if not installed and used in accordance with the instructions, may cause harmful interference to radio communications. However, there is no guarantee that interference will not occur in a particular installation. If this equipment does cause harmful interference to radio or television reception, which can be determined by turning the equipment off and on, the user is encouraged to try to correct the interference by one or more of the following measures: Reorient or relocate the receiving antenna. Increase the separation between the equipment and receiver. Connect the equipment into an outlet on a circuit different from that to which the receiver is connected. Consult the dealer or an experienced radio/TV technician for help.

CAUTION: This product is for non-residential use only.

WARNING: This equipment is compliant with Class B of CISPR 32. In a residential environment this equipment may cause radio interference.

CAN ICES-003(B)/NMB-003(B)



Protective earthing terminal. The apparatus should be connected to a mains socket outlet with a protective earthing connection.

DECLARATION OF CONFORMITY

WIRELESS TRANSMITTER COMPLIANCE INFORMATION: The term "IC:" before the radio certification number only signifies that Industry Canada technical specifications were met.

Le terme «IC:» avant le numero de certification radio signifie seulement que les specifications techniques d'Industrie Canada ont ete respectees.

This device contains licence-exempt transmitter(s)/receiver(s) that comply with Innovation, Science and Economic Development Canada's licence-exempt RSS(s). Operation is subject to the following two conditions (1) this device may not cause harmful interference, and (2) this device must accept any interference, including interference that may cause undesired operation of the device.

Cet appareil contient des émetteurs / récepteurs exemptés de licence conformes aux RSS (RSS) d'Innovation, Sciences et Développement économique Canada. L'exploitation est autorisée aux deux conditions suivantes : (1) l'appareil ne doit pas produire de brouillage, et (2) l'utilisateur de l'appareil doit accepter tout brouillage radioélectrique subi, même si le brouillage est susceptible d'en compromettre le fonctionnement.

This equipment complies with FCC and IC radiation exposure limits set forth for an uncontrolled environment. This equipment should be installed and operated with minimum distance 20cm between the radiator and your body. This transmitter must not be co-located or operating in conjunction with any other antenna or transmitter.

Cet appareil est conforme a FCC et IC !'exposition aux rayonnements limites fixees pour un environnement non controle. Cet appareil doit etre installe et utilise avec une distance minimale de 20cm entre le radiateur et votre corps. Cet transmetteur ne doit pas etre cositue ou operant en liaison avec toute autre antenne ou transmetteur.

EU COMPLIANCE INFORMATION:

Hereby, HARMAN Professional, Inc., declares that the equipment type EON ONE MK2 is in compliance to the following: European Union Restriction of Hazardous Substances Recast (RoHS2) Directive 2011/65/EU; European Union WEEE (recast) Directive 2012/19/EU; European Union Registration, Evaluation, Authorization and Restriction of Chemicals (REACH) Directive 1907/2006; European Radio Equipment Directive (RED) 2014/53/EU

You may obtain a free copy of the full Declaration of Conformity by visiting:
<http://www.jblpro.com/www/product-support/downloads>

This product contains batteries that are covered under the 2006/66/EC European Directive, which cannot be disposed of with normal household waste. Please follow local regulations.

WIRELESS FREQUENCY RANGE AND WIRELESS OUTPUT POWER:
2402MHz - 2480MHz
6.00mW

Prevention of hearing loss



Caution: Permanent hearing loss may occur if earphones or headphones are used at high volume for prolonged periods of time.
Note: To prevent possible hearing damage, do not listen at high volume levels for long periods.

CLASS B PRODUCT:

警告

此为B级产品。在生活环境中，该产品可能会造成无线电干扰。在这种情况下，可能需要用户对干扰采取切实可行的措施。

ENVIRONMENTAL:



此标识适用于在中华人民共和国销售的电子信息产品。标识中间的数字为环保实用期限的年数。

INTRO TO EON ONE MK2

GETTING STARTED

Congratulations on your purchase of JBL Professional EON ONE MK2 loudspeakers! We know you are anxious to get up and running as fast as possible, which is why you are reading this section. The following will help you get set up as soon as possible.

Packaging Contents

Your EON ONE MK2 should include:

- (1) EON ONE MK2 Woofer Cabinet
- (1) EON ONE MK2 Battery Spacer
- (1) EON ONE MK2 Column Spacer
- (1) EON ONE MK2 Linear Array
- (1) 6' (2m) AC Power Cable
- (1) Quick Start Guide

Unboxing

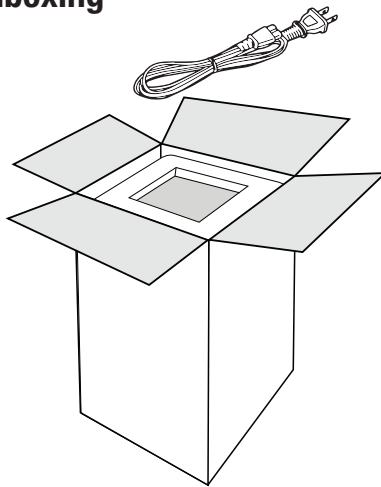

①

Open unit, pull AC cable from top box and remove

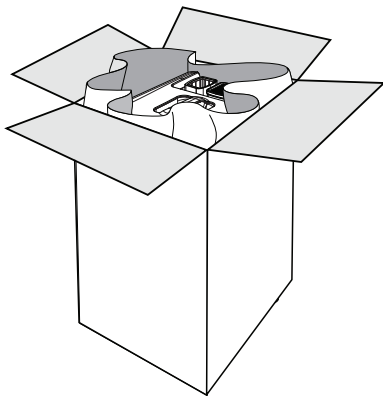

②

Open plastic to expose woofer handle

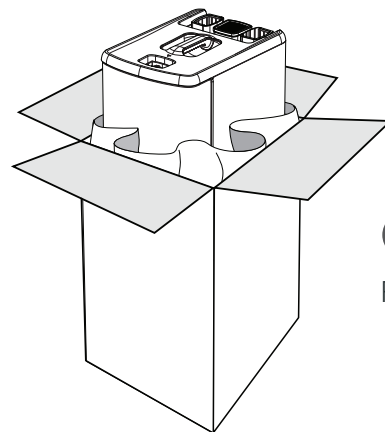

③

Remove woofer

SETTING UP

How to set up

- Plug battery spacer into woofer
- If column spacer is desired, plug column spacer into battery spacer.
- Plug Linear Array into Column Spacer
- Turn on AC Power

How to turn on/off

- Turn on unit by short pressing the power button until the LCD fires on
- Turn off the unit by HOLDING power button for 3s until unit turns off

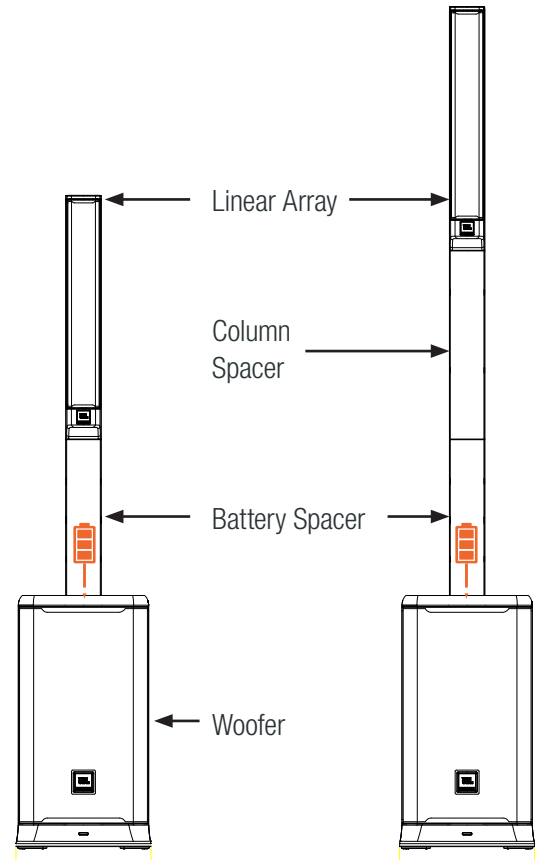
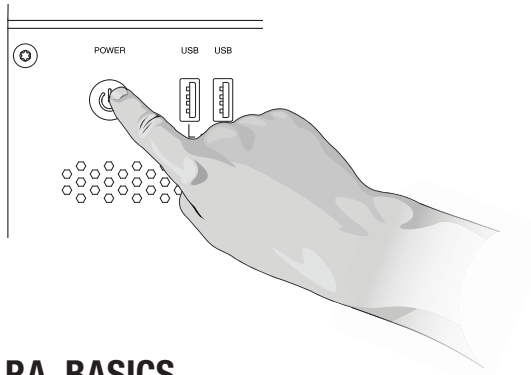

P.A. BASICS

A mixing board is actually a very simple device that takes the audio input signals (from the input channels) and “mixes” them to the outputs. The mixing board controls will typically enable the user to blend the input channel signal levels, affect their tone, and adjust each channel’s reverb level. The signal is then fed from the mixing board to the amplifiers and onto the speakers. The EON ONE MK2 is a self-contained PA system, which includes a mixing board, amplifiers, and speakers.

GETTING ACQUAINTED WITH EON ONE MK2

The powered mixer section of the EON ONE MK2 system houses the mixing board and power amplifier. Here, all of the microphones, musical instruments, and external sound sources (such as MP3 players, CD players, or Bluetooth audio sources) can be connected.

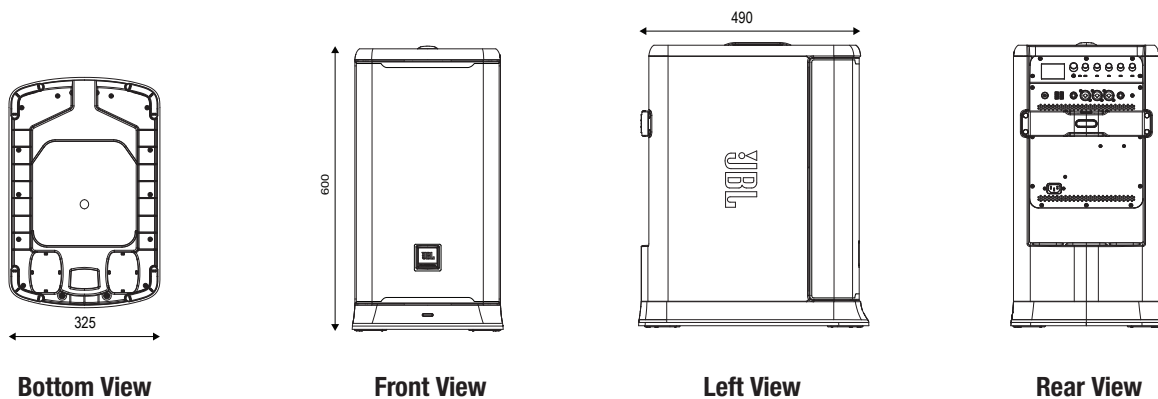

BLOCK DIAGRAM

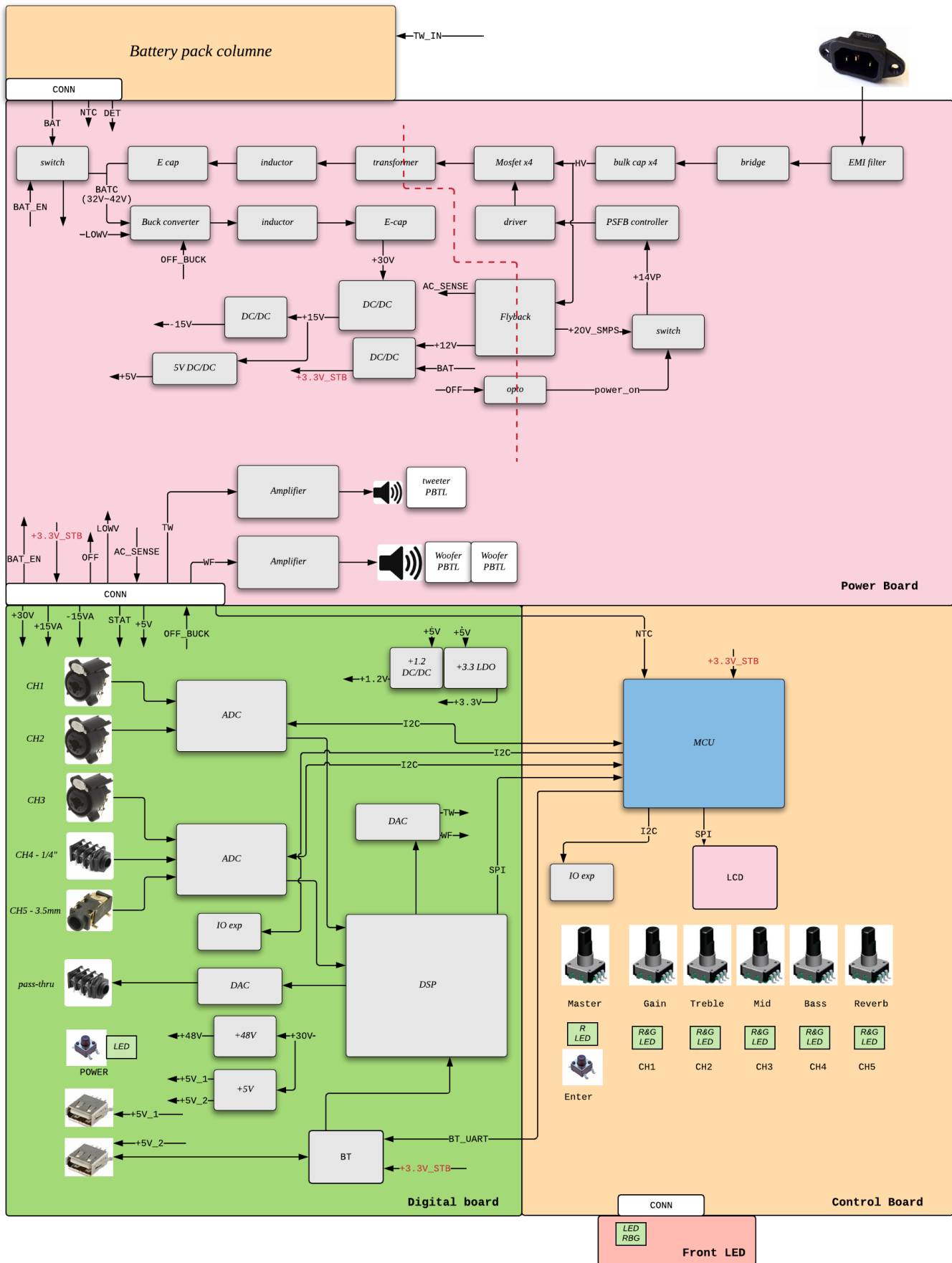

APPLICATION EXAMPLES

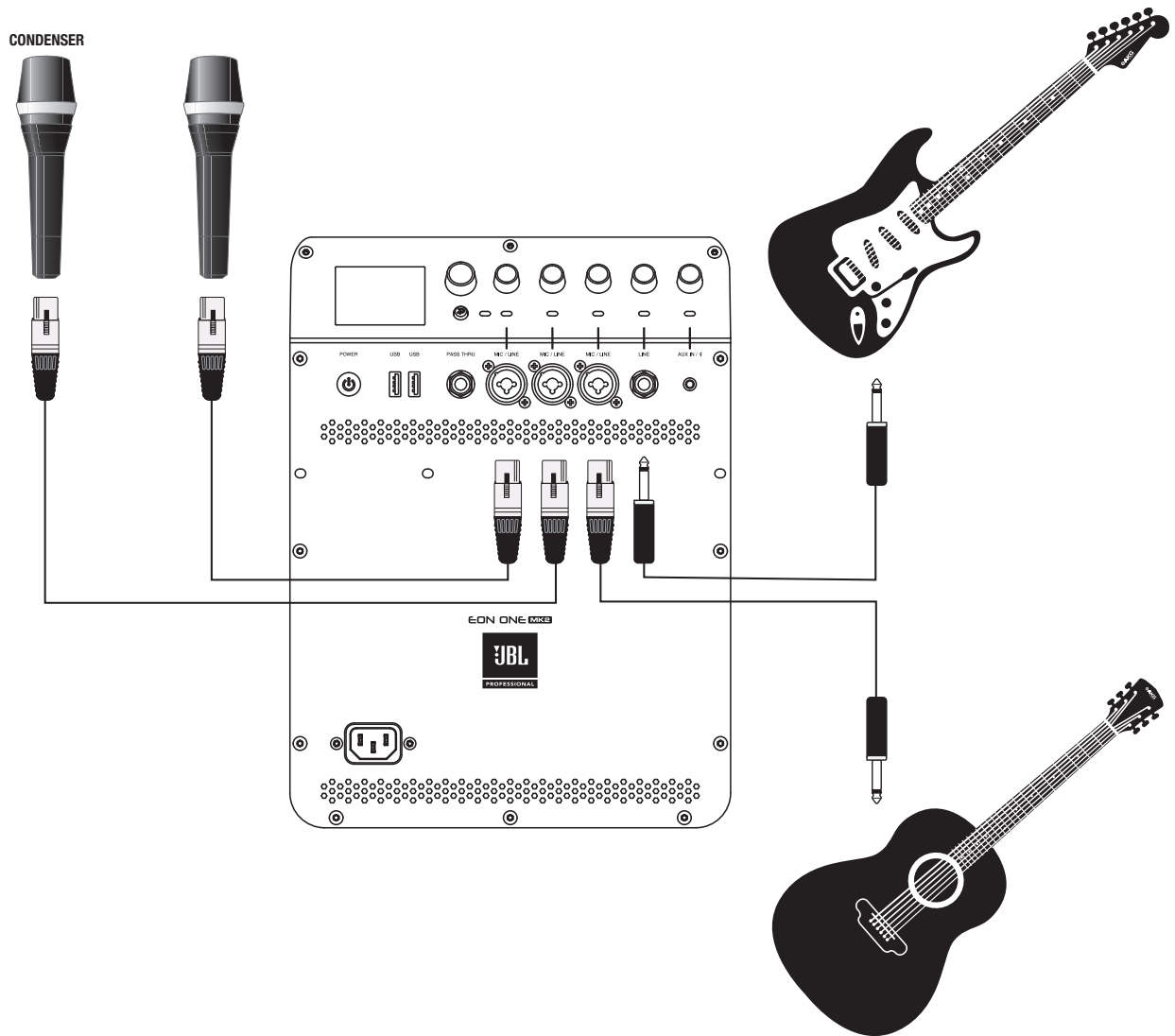

MULTIPLE INSTRUMENTS/MICS PLUGGED INTO MIXER

CH1 XLR-1/4" Combo Condenser Mic, CH2 XLR-1/4" Combo Mic, CH3 Passive Pickup Guitar, CH4 Active Pickup Guitar

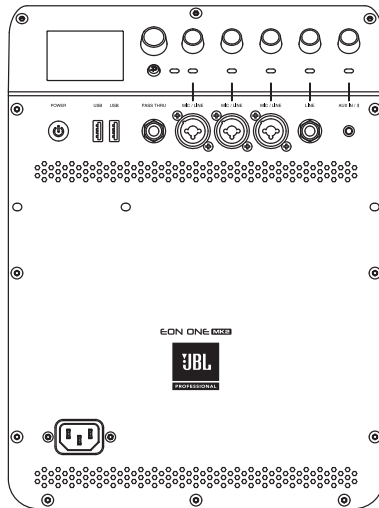
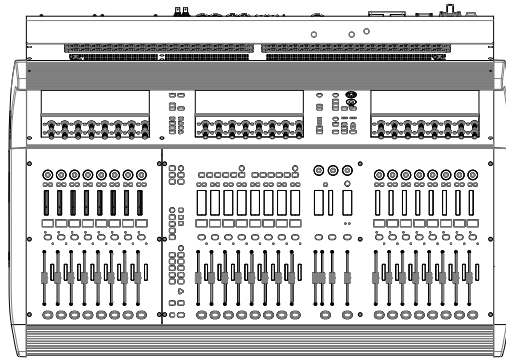

USING TWO SYSTEMS AS MONITORS

EON ONE MK2 Left and EON ONE MK2 Right

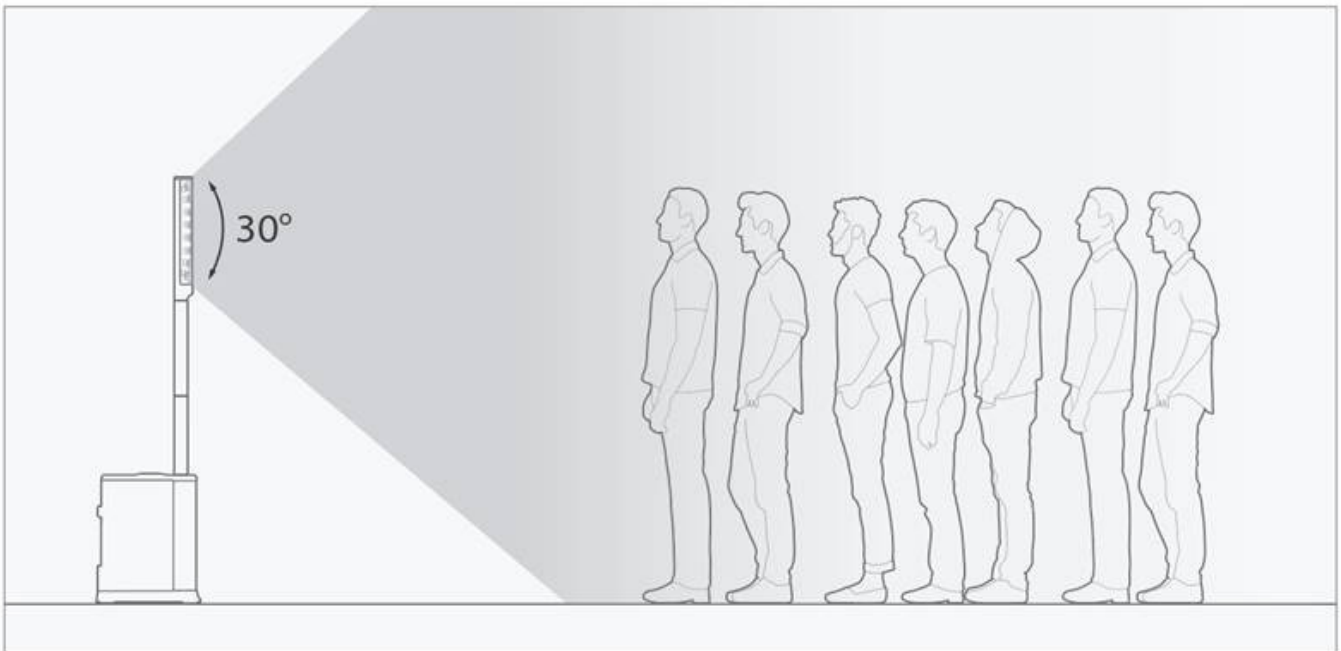
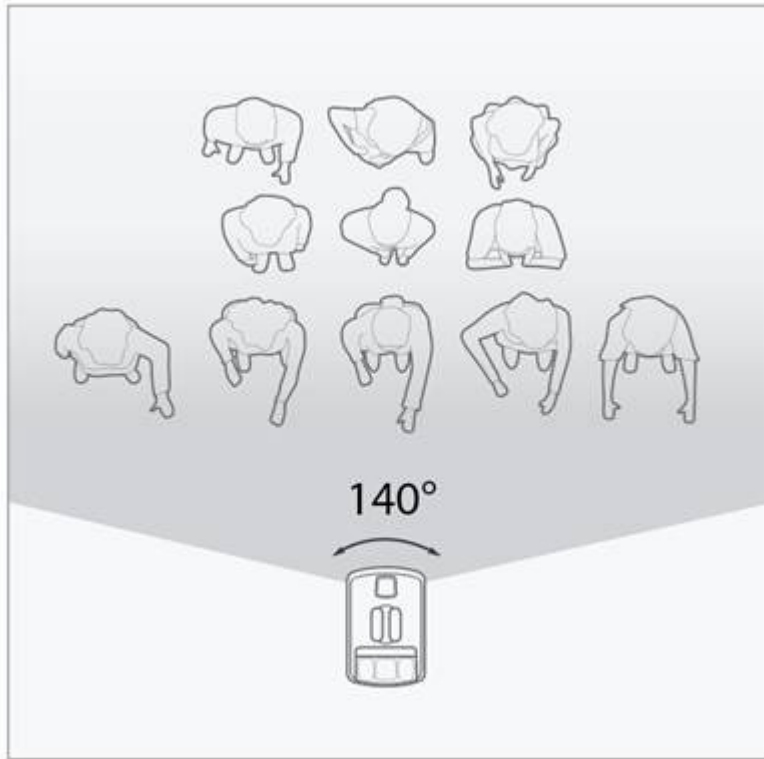

ACOUSTIC DISPERSION
EON ONE MK2

MIXER PANEL

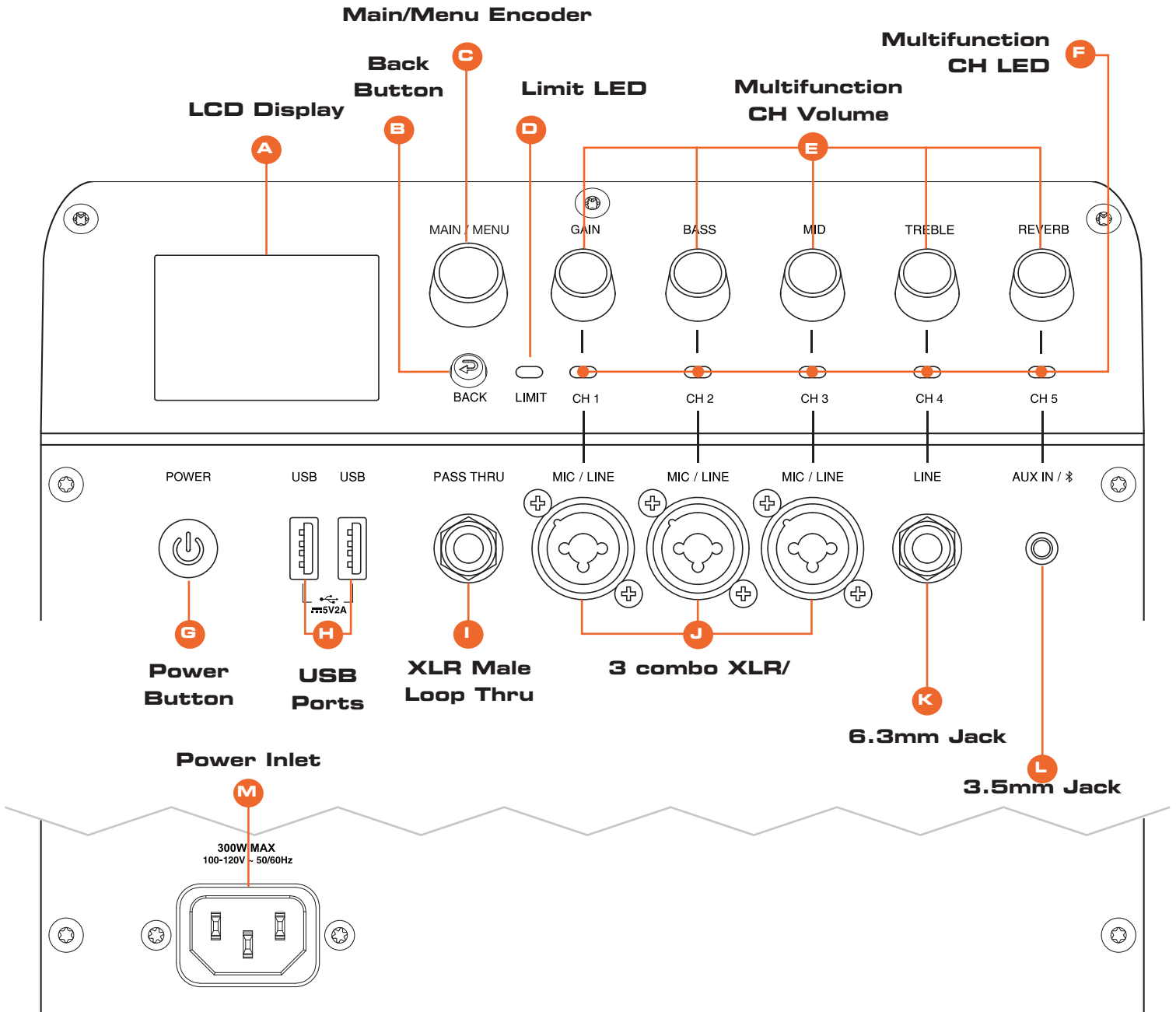

A. LCD Display

The LCD is used to display basic diagnostic information and allow access to more advanced features through a menu system. See the LCD GUI specification for more details on the LCD menu system, features, and navigation. The LCD will refresh at approximately 4Hz and is not suitable for meters or any other fast motion items.

B. Back Button

Press to return to previous menu item. Hold for 2s to engage Mix Mode

MIXER PANEL FUNCTIONS

C. Main Volume / Menu Encoder

Controls LCD Display

- Rotary encoder: In Menu - Clockwise down menu/Anti-clockwise up menu
- Press to select menu item
- + On Home screen, Main Level increase by rotating the knob clockwise.

+ On Home screen, Main Level decrease by rotating the knob counterclockwise. Main encoder with detent: 70+/-40gf.cm

D. Limit LED

Amplifier is reaching clip.

E. Multifunction CH Volume

EON ONE MK2 has 2 unique operation modes of the mixer which can be toggled holding the back button for 2 seconds by pressing a specific channel rotary:

- Mix Mode
- Channel Strip mode

F. Multifunction CH LED's

Channel level represented by colors

Channel Strip Mode: Denotes the selected channel

For SSM signal detection information, please see SSM section.

G. Power Button

The Power Button is a momentary push button. It is used to toggle the unit between the On and Off states. When in the Off state, a short press and release of the Power Button will put the unit into the On state. When in the Sleep state, a press and hold of >2s.

H. USB Ports

- USB Type-A
- Standard USB2.0 Type-A port
- Connecting with device: Charging 2.0 (x2 USB)

I. 1/4" Balanced Pass Thru

This 1/4" Balanced output connector provides a method of sending audio out to an external source. If signal is present on all inputs, the inputs will be summed and sent out as a mix: Can be adjusted in the pass through menu section.

J. 3 Combo XLR-1/4" Inputs

Three female XLR – 1/4" combination connectors (1 for each input) are used for the analog audio inputs.

K. 6.3mm Input

One female 6.3mm connectors (1 for each input) are used for the analog audio inputs.

L. 3.5mm Jack

Two channel single ended input, mono mixed as a single mixed channel.

M. Power Inlet

Inlet adapter for A/C power cable

I/O

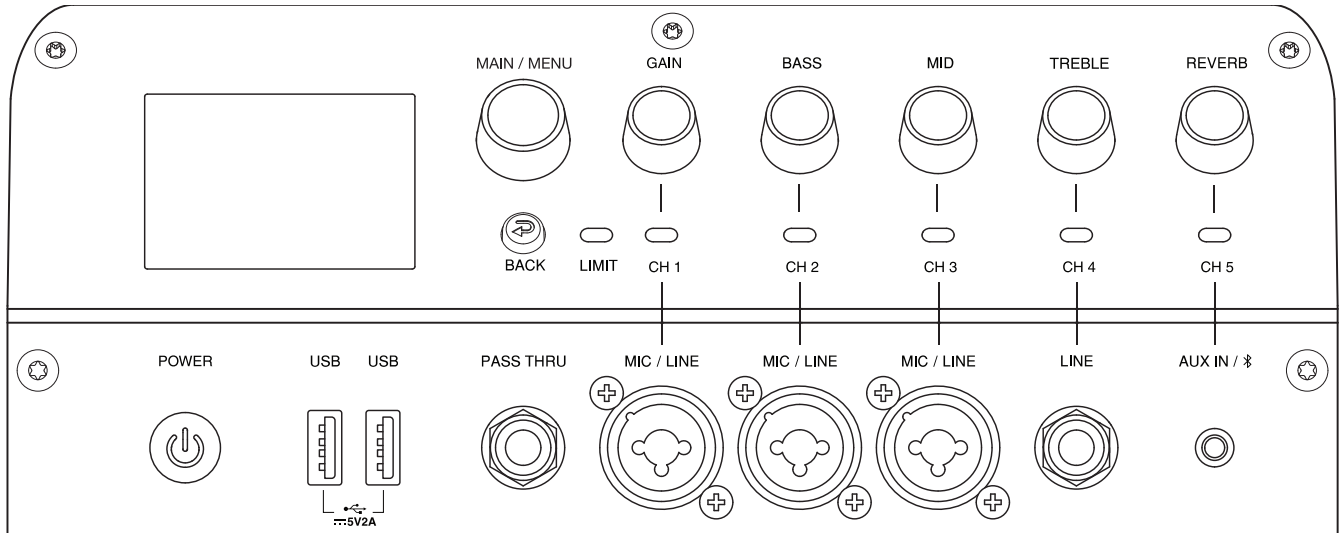

CH 1-2

• Phantom Power disclaimer

When using condenser microphones, +48V phantom power is required to be present at the contacts of the microphone (XLR) connector for the microphone to operate correctly. When phantom power is enabled, it is applied to both the CH1 and CH2 XLR inputs. Ensure that phantom power is off when not required.

To prevent damage to the EON ONE MK2 or external devices when using condenser microphones, always turn down all EON ONE MK2 output controls and ensure the +48V phantom power is off before connecting the microphone. Once the condenser microphone has been connected, enable the +48V phantom power, then raise the output controls to the desired levels.

1. The EON ONE MK2 offers user-selectable phantom power on both channels 1 and 2, turned on via the LCD or the APP.
 - a. To engage phantom power, press the knob for CH1 or CH2 to open the Channel Menu.
 - b. Navigate to Phantom Power and press the Main/Menu knob.

Knobs and Functions

The EON ONE MK2 comes equipped with push-button rotaries to make for easy navigation and hardware usage.

1. A single press of a Channel knob will activate CHANNEL STRIP MODE for that channel.
 - a. Please see the section on CHANNEL STRIP MODE for more clarity.
2. Pressing and holding a CH knob for 2s at any time will mute that channel. Channel LED below muted channel will slowly flash RED.
3. A single press of the MAIN/MENU knob will open up the main menu, unless you are in a channel menu screen. In channel menu screens, the MAIN/MENU knob controls your main navigation through these screens.
4. Pressing and holding the MAIN/MENU for 2s while on the home page will mute the SPEAKER.

Buttons and Functions

1. The BACK button will back you out of the current screen you are in without saving changes. This can be thought of as a “CANCEL” button.
2. Holding the back button for 2s will engage Mix Mode

Mix Mode

1. Press and Hold the BACK button for 2s to engage Mix Mode
 - a. All LEDs will turn ON, indicating you've successfully initiated Mix Mode
2. In mix mode, the knobs will now control their respective channel gains. For example, twisting the knob labeled CH1 will increase the gain of CH1.
3. EON ONE MK2 has an automatic mic/line switch. Between -100dB and 0dB, the channel will be in LINE mode. Between 1dB and 56dB, the channel will be in MIC mode.

Channel Strip Mode

1. Access Channel Strip mode by
 - a. Press the rotary knob of the channel you wish to edit.
2. When in Channel strip mode, the knobs control the respective listed function of the selected channel (i.e. Gain, Bass, Mid, Treble, Reverb Send, Delay Send, Chorus Send)

LEDs and Functions

1. Signal detection - LED below channel knobs will periodically flash yellow to indicate signal is present.
2. LED function when Muting Channels/Speaker : LED Below Channel knobs will slowly flash RED when a channel is muted.

SSM

Signal Level for LED Metering	Mix Mode	Channel Strip Mode
Clipping	Channel LED Bright Red	Selected Channel LED Bright Red
Strong signal	Channel LED Bright Yellow	Selected Channel LED Bright Yellow
Weak signal	Channel LED Bright Green	Selected Channel LED Bright Green
No/Low Signal	All LED Dim Green	"Selected Channel LED Dim Green"
Mute	Muted channel LEDs flashes Dim Red	"Selected Channel LED flashes Dim Red"

EASYNV LCD

Intro to the EasyNav LCD



Main Menu

1. Pressing the Main/Menu rotary at any time will take you to the EON ONE MK2's main menu. Here, users can access the main menu functions of the EON ONE MK2.
2. "Ducking by Soundcraft" is a type of side-chain compressor most often used to lower the level of music playback while a person is talking into a microphone. This feature allows the user to choose which mic channels to use as sensors, the sensitivity of each channel, and the amount of music reduction while a person is speaking. This menu engages the ducking feature, allows users to select which channel(s) will act as the trigger for ducking, and set individual thresholds of each channel.
 - a. To access this menu, navigate to ducking and press the Main/Menu button.
 - b. To turn on ducking, navigate to Ducking and press the Main/Menu button
 - i. Turn the knob CLOCKWISE to activate ducking
 - ii. Turn the knob COUNTER-CLOCKWISE to disable ducking
 - c. "Channel Sensors" give the user the option to select which mic inputs can be used to trigger the Bluetooth playback music ducking. The user can select any combination of the mic inputs to turn on as sensors for Bluetooth music ducking.
 - i. To adjust the Channel Sensor, navigate to the Channel Sensor field and press the Main/Menu button
 - . Navigate to the respective channel(s) you wish to set as a sensor and press the Main/Menu button
 - . Turn the knob CLOCKWISE to activate that channel as a SENSOR for ducking. When this is selected, the respective channel will detect signal and activate the ducking feature on CH5.
 - . Turn the knob COUNTER-CLOCKWISE to disable that channel as a SENSOR for ducking. When this is disabled, signal detection on this channel will NOT trigger the ducking feature on CH5.
 - d. "Sensitivity Parameters" give the user the option to select at what volume level each mic input channel will trigger the ducker threshold. Stronger voices may want a higher sensor level. Weaker voices may want a

lower sensor level to trigger the music reduction. A lower value represents a less sensitive signal detection.

- i. Select and edit these values by pressing the Main/Menu knob while Sensitivity Parameters is highlighted.
 - . Navigate to the respective channel you wish to edit and press the Main/Menu knob to select.
 - . Adjust the parameter.
 - . Press the Main/Menu knob to save the adjustment
 - . Press the BACK button to cancel this adjustment.
- ii. Range is a parameter that tells CH5 how much volume should be reduced when signal detection meets the desired level.
 - . To adjust this, navigate to RANGE and press the Main/Menu knob.
 - . Adjust the parameter
 - . Press the Main/Menu knob to save the adjustment
 - . Press the BACK button to cancel this adjustment.
- iii. Release Time is a parameter that tells CH5 when it should return to normal volume after signal is no longer detected. This value is represented in ms (milliseconds).
 - . To adjust this, navigate to RELEASE TIME field and press the Main/Menu knob.
 - . Adjust the parameter
 - . Press the Main/Menu knob to save the adjustment
 - . Press the BACK button to cancel this adjustment.

3. FX Processing is where users access the effects parameters, minus sends, of the Lexicon effects engine.

- a. The EON ONE MK2 offers a Lexicon effects engine that provides users with Reverb, Delay, Chorus and Sub-synth effects.
 - i. Navigate to the FX Processing menu in the Main/Menu and press the knob to access.
 - ii. Here you will be able to turn the effect on/off, edit the main parameters of the effect and access presets.
- b. Reverb by Lexicon Parameters
 - i. “On/Off”
 - . When set to off, the Reverb by Lexicon input is disabled. When turning this off while active, the current reverb sound will continue to ring out. To reduce it immediately, reduce the Level To Mix setting.
 - ii. “Reset” will set the Reverb by Lexicon to off and adjust the settings to “Room Medium” default preset, to start over as a factory default.
 - iii. “Presets” offers users a selection of common settings for fast selection in typical use cases. These reverb settings are named as descriptions of the types of rooms or halls they simulate.

-
- . Presets assist new users wanting to try quick examples of often-used reverb setting combinations.
 - . The user can select “Custom” and adjust all the settings themselves. Or they can start with one of the location description presets, listen, and then add any settings adjustments, which automatically load the new combination of settings into the “Custom” setting for further adjustments.
 - . Custom
 - . Room Small
 - . Room Medium
 - . Room Medium Bright
 - . Room Large
 - . Hall Medium
 - . Hall Medium Bright
 - . Hall Large
 - iv. The combination of “Size” and “Pre-delay Time” define the reverb simulation in just two controls; how big the room is (Size) and how far away the audience member feels they are in regard to the performers.
 - . Size adjusts the theoretical size of the simulated room in short, medium, long or longer.
 - . Pre-delay simulates the ratio of time from the source signal to the listener to the delay of the first reflection off the closest wall.
 - . A shorter pre-delay time will make the audience feel farther away from the source
 - . A longer pre-delay time will make the audience feel closer to the source.
 - v. The High Frequency parameter simulates how much high-frequency reflections are in the reverb.
 - . Simulating the sound of a room with many metal or glass surfaces is an example of a scenario with more high-frequency reflections.
 - . Simulating the sound of a room with soft wood or outdoor settings would be an example of less high-frequency reflections.
 - vi. The Low frequency parameter simulates the amount of bass building in the reverb.
 - . An indoor, hard surface room will accumulate more bass build-up.
 - . An outdoor simulation would generate less bass build-up.
 - vii. The Level to Mix Parameter is the amount of wet signal (or signal with reverb) that is sent back to your main mix.
 - . Increasing the level to mix will create a more prominent reverb effect.
 - . Decreasing the level to mix will create a more subtle reverb effect.
 - viii. To adjust any parameter, navigate to the parameter using the MAIN/MENU knob. Press the MAIN/MENU knob to access.
-

-
- . Adjust the values by turning the knob CLOCKWISE or COUNTER-CLOCKWISE.
 - . Press the MAIN/MENU knob to accept these changes. Press the BACK button to cancel these changes.
- c. Delay - The FX Processing Delay is designed to be a musically oriented delay, commonly used on rock and ballad vocals and guitars. It is often set to match the specific “Beats Per Minute” (i.e. “BPM”) of the song currently being performed, plus how many delay returns are desired per beat, how long the delay keeps returning and if the delay feeds back again multiple times.
- i. “On/Off” When set to off, the Delay input is disabled. This allows the current signal to “ring out” until the current delay signal is completed. To end the delay immediately, turn down the Delay Level to Mix fader.
 - ii. “Reset” will set the Delay processing settings to default settings.
 - iii. “Presets” offers a quick selection of common settings for fast selection in typical use cases. These delay settings are named as descriptions of the types of common musical uses they simulate. Presets can assist new users wanting to try quick examples of often-used delay setting combinations. The user can select “Custom” and adjust all the settings themselves. Or they can start with one of the location description presets, listen, and then adjust any settings desired. When a user has selected a preset and then adjusts a setting, all current delay settings are loaded into the Custom preset for further editing.
 - . Custom
 - . Simple Quarters
 - . Simple Eights
 - . Simple Triples
 - . Simple 1:1
 - . Staggered Echo
 - . Bounce wall
 - . Fast Spring
 - iv. “Beats Per Minute” enters the beats per minute tempo of the song planned or in progress. The speaker automatically calculates the delay times to match the beats per minute song tempo.
 - v. “SubDivision” enables the user to enter the number of times the delay returns the signal per beat. For example, if this is set to “1:2” then for every beat there are two delay returns heard.
 - vi. “Delay Length” is the setting showing how long, represented in milliseconds (ms), the delays will continue returning for each beat. The smaller the number, the faster the delay returned signal will fade out per beat.
 - vii. “Feedback” is the amount of the delayed signal that is fed back into the Delay processor input, to give more depth to the delay sounds.
 - viii. “Low Pass Filter” can be set to reduce the relative level of high frequencies of the delay returned signal. If the user perceives bright high-frequency harshness resulting from very bright source signals,

this setting can be lowered to compensate.

- ix. “Level to Mix” sets the amount of final delay signal that contributes to the FX Return fader.
 - . To adjust any parameter, navigate to the parameter using the MAIN/MENU knob. Press the MAIN/MENU knob to access.
 - . Adjust the values by turning the knob CLOCKWISE or COUNTER-CLOCKWISE.
 - . Press the MAIN/MENU knob to accept these changes. Press the BACK button to cancel these changes.

- d. Chorus The FX Processing Chorus is designed to add a musically oriented light shimmer on rock or ballad vocals and acoustic guitars. Chorus is often used very lightly to enhance the harmonic content and character, to bring out more shine on pure wave types of natural musical sources.
 - i. “On/Off” When set to off, the Chorus input is disabled. This allows the current signal to “ring out” until the current Chorus signal is completed. To end the Chorus process result immediately, turn down the Chorus Level to Mix fader.
 - ii. “Reset” will set the Chorus processing settings to default settings.
 - iii. “Presets” offers users a quick selection of common setting combinations for fast selection in typical use cases. These Chorus presets are named as descriptions of the types of common musical uses they simulate. The user can select “Custom” and adjust all the settings themselves. Or they can start with recalling one of the presets, listen, and then add any settings adjustments, which will automatically load the new combination of settings into the “Custom” setting for further editing.
 - . Custom
 - . Slow Light
 - . Slow Deep
 - . Fast Light
 - . Fast Deep
 - . Smooth Vibrato
 - . High Pass
 - . Medium Narrow
 - iv. “Rate” adjusts the speed of vibration of the chorus effect.
 - v. “Depth” adjusts the length of time the chorus process takes to ring out over time.
 - vi. “Width” adjusts how wide the chorus process resonates above the source frequencies.
 - vii. “Level to Mix” is the amount of the Chorus signal sent to the FX Return fader, which then contributes to the final mix.
 - . To adjust any parameter, navigate to the parameter using the MAIN/MENU knob. Press the MAIN/MENU knob to access.
 - . Adjust the values by turning the knob CLOCKWISE or COUNTER-CLOCKWISE.
 - . Press the MAIN/MENU knob to accept these changes. Press the BACK button to cancel these changes.

-
4. dbx DriveRack Output is a line of hardware products produced by Harman's dbx brand. These rack mount signal processors provide detailed control for final processing and crossovers before feeding the mix to one or more speakers. This DriveRack functionality embedded into EON ONE MK2 is designed to optimize the combination of speaker and Pass Thru outputs built into this JBL speaker.
- a. AFS, or Automatic Feedback Suppression, is a combination of processing that can enable the user to add up to 3 dB more total gain to their output before getting audio feedback back in through the mix inputs. dbx AFS does this using a combination of auto-sensing and very tight width parametric EQs before the output main EQ. Locked filters can be setup before an event as "fixed" filters. Plus live AFS filters can be turned on to continue chasing the latest feedback frequency risks during an event, such as changes caused by handheld microphones moving positions and directions while on stage.
 - i. **Stage setup best practices are always recommended for best results to avoid feedback, in combination with the AFS processing system. Microphones have less chance of contributing feedback if they follow the following position standards on stage:**
 - **Microphones should be behind the front plane of the speakers.**
 - **Microphones should be least two meters to the left or right of the speakers.**
 - b. "AFS by dbx" On/Off selection toggles the AFS processor on or off.
 - c. "Live AFS" On/Off selection toggles the live AFS filters on or off. Live filters are best for catching feedback on stage from microphones that are moving around the stage. Turning on "Live AFS" is the fastest, easiest way to start using AFS processing.
 - d. "Reset Live Filters" will reset all live filters, prompting the filters to reset and start over in their discovery of potential feedback frequency risks.
 - e. "Learn Fixed" starts the automatic discovery and setup of the Fixed AFS filters. While the microphones are plugged in before the show and speakers are turned on, enable the "Learn Fixed" function. Then walk over to the nearest mics and speak loudly into them to try to induce feedback. If no feedback is found, turn up the main volume slowly until feedback rings and is suppressed by a fixed AFS filter. Each time the speaker's AFS system notices feedback frequency it will automatically apply a fixed filter at that frequency. Continue speaking into the mics, including moving around the performer with handheld mics, speaking loudly into the mics.
 - i. Turn off the "Live AFS" while operating the Learn Fixed setup.
 - ii. When all fixed frequencies have been filled, the "Learn AFS" will automatically turn off and the Fixed Filters are locked on for the event.
 - iii. If the user is unable to get all the fixed AFS filters to complete frequency assignments, the user can manually turn off "Learn AFS" by clicking the "Learn Fixed" setting again. Turning off "Learn AFS" automatically leaves on the Fixed AFS On/Off setting.
 - iv. After completion of the Learned Fixed setup, turn on "Live AFS" for additional feedback suppression during a live event.
 - f. "Remember Fixed on Reboot" Speakers are sometimes used in the same setup for extended times. During this time speakers may be powered on and off multiple times. Turning on "Remember Fixed on
-

Reboot” sets the fixed AFS filters to maintain their found frequency assignments on next speaker bootup. In general, most users will leave this setting turned on, in case power is accidentally dropped in between the soundcheck AFS Fixed filter setup and the event. Groups that move speakers to new locations often may desire to set this feature off, as each location has different feedback challenges, which previous Fixed filters would not assist.

5. The Main EQ is a package of filter adjustments on the main mix before the audio feeds to the amp and speaker. It includes a collection of easy to select preset curves for common speech and music styles. Each preset can also be loaded into the Custom preset for detailed user-adjustable of output parametric EQs. The user has adjustments for individual band level, frequency, and width (“Q”).
 - a. “Main EQ” On/Off enables or bypasses the current settings in the Main EQ processor.
 - b. “Reset” selection resets the Main EQ to flat, as the default Main EQ setting when shipped.
 - c. “Presets 8x” enables rotation of the Main/Menu knob to view and select from the Main EQ presets.
 - i. Scroll the menu to “Presets 8x” and press the MAIN/MENU knob.
 - ii. Rotate the MAIN/MENU knob to view the available presets.
 - iii. Click the MAIN/MENU knob to load the currently showing preset.
 - iv. Users can load the Custom preset, then double click the Main/Menu knob to open the Main EQ editing page. Inside this graph display page, you may rotate the Main/Menu knob to a specific parametric EQ number and click the Main/Menu knob again to select to edit the gain (plus or minus in dB), filter frequency, or “Q” (i.e. adjust the filter width.)
 - . Users can load any preset as a starting point, then scroll down and adjust any setting to load the current curve as the Custom preset for further editing. **A confirmation dialog will appear, warning the user that doing this will remove the current Custom preset settings and load it with the currently viewed settings.**
6. The Output Limiter provides a “brick wall” limiter on the main mix, after the Main EQ in the signal chain.
 - a. Limiters reduce the loudest parts of the mix dynamic range. Limiters can be used either for protection when playing very loud source material, or to creatively sculpt down the loudest dynamics of the main mix. Carefully turn up the Makeup Gain to compensate for low threshold limiter results.
 - b. “Reset” is an action command to reset the Output Limiter to the factory default setting.
 - c. “Presets” are available to recall limiter settings for common creative situations or trouble shooting.
 - i. If the user selects any of the lower three settings to edit, the preset automatically loads the lower three settings to the Limiter “Custom” preset for further user editing.
 - d. “Threshold” enables the user to set the threshold level, limiting the maximum mix level to amp and speakers. All dynamic range above that level will be limited down to the maximum Threshold setting.
 - e. “OverEasy” an Enabling “OverEasy” smooths the transition before the signal reaches the Threshold level to provide a smooth limiting audio result. “OverEasy” is often selected on rock ballads or speaking panels. Turning off OverEasy is often desired on harder rock or DJ style of music program.
 - f. “Makeup Gain” can be used to raise a limited mix to pre-limiter levels. Warning: Using limiter “Makeup

Gain” on already loud mixes may exceed desired mix gain levels. This setting is best used only by skilled audio professionals. Small movements are best when adjusting limiters.

7. Pass Thru and Time Align - Thru XLR output can be set to assist in feeding the mix to additional speakers. This section includes presets and settings based on the type of speaker the Pass Thru will be feeding and how it is positioned in comparison to this speaker and the audience.
 - a. “Pass Thru” On/Off” enables or disables the Pass Thru XLR output feed.
 - b. “Presets” enables selection of three types of speakers combinations using the Pass Thru XLR output.
 - c. “Full Range” is designed for feeding another full range speaker. This feeds both this and the Pass Thru XLR out to another speaker with the same full frequency range mix.
 - d. “Sub” preset automatically configures the below settings for isolating low frequencies and only feeding them to Pass Thru XLR out for a subwoofer speaker. Selecting “Sub” automatically sets the internal amp/speaker feed to HPF (“high pass filter”) only signal at above 80Hz and the Pass Thru XLR output to only pass the mix signal below 80Hz.
 - e. “Custom” allows the user to set the lower settings manually.
 - f. “HPF on this Speaker” can be used to remove signal below a selected frequency to the built-in amp/speaker and tweeter bar.
 - g. “LPF on Pass Thru Out” can be used to set the low pass filter on the Thru Out XLR output feed.
8. Time Align
 - a. Signal delays are used when multiple speakers are in use but speakers are at different distances from the audience.
 - b. Examples:
 - i. A subwoofer in front of the stage, while this full-range speaker is on the stage. In this configuration, the Pass Thru XLR to subwoofer will need to be slightly delayed to make up for its closer position to the audience.
 - ii. The Array bar extender option is used to mount the speaker bar in a off-speaker location at a slightly different distance to the audience. In this case, delay the device closest to the audience to align with the device farthest from the audience.
 - iii. The Pass Thru XLR out is feeding an additional full-range speaker placed half-way back in the audience to give additional listening distance. In this case, delay the back fill speaker in the audience to compensate correct time alignment.
 - c. Time Alignment Basics:
 - i. To compensate for different distances’, determine the speaker farthest from the audience and delay other speakers with the same signal to “time align” with the speaker farthest away from the audience.
 - ii. Sound travels through air at average humidity and room temperature at about 1.1 feet per ms (3ms per 1m). Measure the difference in distance of each speaker feeding the audience. Feed the speaker farthest from the audience with no time alignment delay. Set delays for the other closer speakers based on their distance ahead of the farthest back speaker. Measure the distance difference and

enter 1 ms per 1.1 feet that each speaker is ahead of the farthest back speaker in your configuration. Time alignment is not perfect as not all audience positions measure the same speaker distance differences.

- iii. “Delay Pass Thru Out” Using this delay will place speaker delay on the PASS THRU Output.
- iv. “Delay This Speaker” Using this delay will place the delay on the INPUT of the mixer of the current speaker.

Channel Menu

1. The channel menu can be accessed by pressing the rotary knob of the respective channel you wish to access. The active channel is visible at the top line of the LCD as well as by the dynamic LED below the respective channel number..
 - a. The MUTE field will mute the respective channel.
 - i. While in mute, the SSM LED of the muted channel will fade RED.
 - ii. You can also MUTE a channel by holding the respective channel knob for 2s.
 - b. Channels 1-2 offers users +48v of Phantom Power. You can engage this in the Channel Menu section. Please refer to the Phantom Power section of this guide for more information.
 - c. The Input EQ section accesses the fixed and parametric EQ for each channel. The input channel EQs are filter adjustments on the audio input channels.
 - i. Presets include a collection of easy to select preset curves for common creative uses.
 - ii. Input channel EQ's include a high pass filter for reducing the combined low-frequency energy build-up on stage, Bass/Middle/Treble simple controls that can be adjusted on the hardware channel knobs or LCD screen, and parametric EQ bands with individual gain, frequency, and width (“Q”) for fine filter editing control.
 - iii. “Channel #” On/Off enables or bypasses the input channel EQ processor.
 - iv. “Reset” Selecting the “Reset” sets the input channel EQ to factory default, i.e. flat curve.
 - v. “Presets 8x” opens the user selection of Input EQ presets.
 - . Users can rotate the Main/Menu knob to see the available input EQ presets.
 - . Click the Main/Menu knob to load the current showing preset.
 - . With any input EQ preset showing, users can double click the Main/Menu knob to open the input EQ editing page.
 - . Inside the EQ editing page, rotate the Main/Menu knob to select the HPF (high pass filter), the Bass/Middle/Treble controls, or select any parametric EQ band number and click the knob to load editing on that band.
 - . On Parametric EQ bands, rotate and select different settings to edit, including gain (plus or minus in dB), filter frequency, or “Q” (i.e. adjust the filter width.)

-
- vi. To access the channel EQ settings, rotate the MAIN/MENU knob to the INPUT EQ field and PRESS the MAIN/MENU knob.
 - d. The FX Send section accesses the sends to each respective effect. All FX sends are “post fader level,” so when a user adjusts the channel fader, the same relative level or mute is reflected on the channel FX send.
 - i. To access, navigate to the FX Send section and Press the MAIN/MENU knob.
 - ii. Navigate to the effect send you wish to change and press the MAIN/MENU knob.
 - . A clockwise turn will increase the effect send.
 - . A counter-clockwise turn will decrease the effect send.
 - . Press MAIN/MENU to save your edits.
 - . Press BACK to cancel your edits.

Settings

1. “BT Audio Pairing” enables Bluetooth audio pairing for up to 30 seconds. This setting turns off when a pairing has been made, or after 30 seconds.
2. “BT Control Pairing” resets Bluetooth control pairing for up to 30 seconds with the JBL Pro Connect app. This turns off when a pairing has been made, or after 30 seconds.
3. When activating BT pairing, a pairing window will pop-up indicating BT Pairing has been initiated. Once successfully paired, this window will disappear.
4. “LCD Contrast” allows the user to adjust the LCD contrast between 0 and 100%.
5. “Firmware Version” shows the current firmware version loaded onto the speaker.
6. “Factory Reset” resets all settings in the speaker to factory default, including Bluetooth communication pairing.
7. To help prolong the life of your battery and conform with ErP regulatory guidelines, the EON ONE MK2 comes equipped with an auto-sleep feature that operates when the unit is on battery.
 - a. to enable/disable, press MAIN/MENU on the ERP field and toggle ON/OFF.
8. SLEEP defines how long it takes until your EON ONE MK2 goes into sleep mode when no audio is detected.

APP

JBL Pro Connect

The JBL Pro Connect app is a Bluetooth Low Energy control application used to remotely control the features within the EON ONE MK2. The app is a free download on iOS and Android.

It is recommended that all users download the app and ensure their unit is operating on the latest firmware for the best experience.

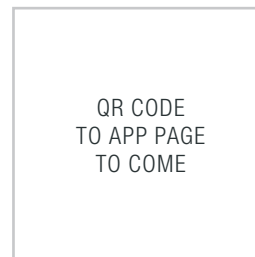

BATTERY SPECS

Cell Model	Nominal Voltage	Wh	Recommended Operating Temp
INR18650-MH1	36V	97.2Wh	15~35°C

To charge your battery, remove the column with the battery indicator from the woofer and place it into the woofer hook up. Power LED will light GREEN, indicating the battery is charging.

For Battery level, please refer to the battery icon on the LCD or the battery icon on the JBL Pro Connect App.

OPTIONAL ACCESSORIES

**SPARE BATTERY
DUAL BATTERY CHARGER**



EON ONE MK2 SPECIFICATIONS

TECHNICAL SPECIFICATIONS

System Type	Powered Column PA Speaker
Woofer Size	10"
Tweeter Size	2"
Tweeter Count	8
Max SPL	123db/119dB AC/Battery
Freq Range -10	37-20kHz
Freq Range -3	45-20kHz
Hor Dispersion	140°
Vert Dispersion	30°
Power Rating	1500W Peak 400W RMS
AC Power Input	300W 100-230V AC 50-60Hz
Input Impedance	4k Ω balanced Combo 2M Ω balanced Hi-Z Jack 10k Ω 3.5mm single ended 2 channel.
Crossover Freq	230Hz
I/O	1 X1/4" balanced
Cabinet	PP
Net Weight	19.3kg (42.5 lbs.)
Gross Weight	22.38kg (49.3 lbs.)
DIMs	452 x 627 x 730mm (17.8 x 24.7 x 28.7 in.) (WxDxH)
Battery	97.2 WH, 36V, Lithium Ion

CABLES & CONNECTORS

XLR/F to XLR/M Microphone Cable	The standard cable for interconnection of microphone and line level signal in professional audio systems. • Microphone to mixer
TRS (balanced) 1/4 inch (6.35mm) phone jack to XLR/M	For connecting balanced devices with 1/4 inch (6.35mm) phone and maybe used interchangeably.
TRS (unbalanced) 1/4 inch (6.35mm) phone jack to XLR/M	For connections of instruments with unbalanced outputs to balanced XLR inputs.
TS (unbalanced) 1/4 inch phone (6.35mm) jack to XLR/M	This cable is electrically identical to "TRS" (unbalanced) 1/4 inch (6.35mm) phone and may be used interchangeably.
XLR/M to RCA (phono) cable	Connects consumer audio products and some DJ mixer outputs to professional audio equipment inputs
TRS 1/4 inch Phone jack to dual 1/4 inch (6.35mm) Phone jack	Splits a stereo output into separate left/right signals.
TRS 1/4 inch Phone jack to dual 1/4 inch (6.35mm) Phone jack	Change to a TRS mini-phone jack to connect to the output of a portable. MP3/CD – player and computer sound cards to a mixer.
XLR/F to XLR/M audio ground lift	Only with balanced in - and outputs

XLR/F to XLR/M Microphone Cable

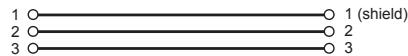

TRS (Balanced) 1/4" Phone to XLR/M Cable



TRS (Unbalanced) 1/4" Phone to XLR/M Cable



TS (Unbalanced) 1/4" Phone to XLR/M Cable

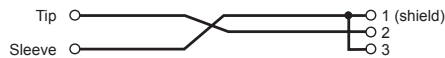

XLR/M to RCA (Phono) Cable

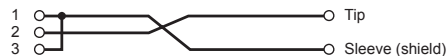

TS (Unbalanced) 1/4" Phone to RCA (Phono) Cable

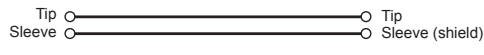

TRS 1/4" Phone to dual TS 1/4" Phone Cable

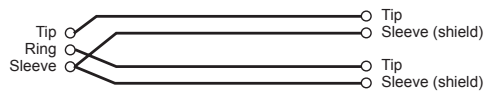

XLR/F to XLR/M Audio Ground Lift Adapter

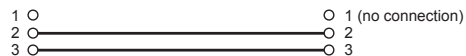
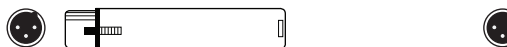

CONTACT INFORMATION



Mailing Address:

JBL Professional
8500 Balboa Blvd.
Northridge, CA 91329

Shipping Address:

JBL Professional
8500 Balboa Blvd., Dock 15
Northridge, CA 91329
(Do not return product to this address without first obtaining prior authorization from JBL)

Customer Service:

Monday through Friday
8:00am -5:00pm
Pacific Coast Time in the U.S.A.

(800) 8JBLPRO (800.852.5776)

www.jblproservice.com

On The World Wide Web:

www.jblpro.com

Professional Contacts, Outside the USA:

Contact the JBL Professional Distributor in your area.
A complete list of JBL Professional international distributors is provided at our U.S.A. website: www.jblpro.com

WARRANTY INFORMATION

The JBL Limited Warranty on professional loudspeaker products (except for enclosures) remains in effect for five years from the date of the first consumer purchase. JBL amplifiers are warranted for three years from the date of original purchase. Enclosures and all other JBL products are warranted for two years from the date of original purchase.

Who Is Protected By This Warranty?

Your JBL Warranty protects the original owner and all subsequent owners so long as: A.) Your JBL product has been purchased in the Continental United States, Hawaii or Alaska. (This Warranty does not apply to JBL products purchased elsewhere except for purchases by military outlets. Other purchasers should contact the local JBL distributor for warranty information.); and B.) The original dated bill of sale is presented whenever warranty service is required.

What Does The JBL Warranty Cover?

Except as specified below, your JBL Warranty covers all defects in material and workmanship. The following are not covered: Damage caused by accident, misuse, abuse, product modification or neglect; damage occurring during shipment; damage resulting from failure to follow instructions contained in your Instruction Manual; damage resulting from the performance of repairs by someone not authorized by JBL; claims based upon any misrepresentations by the seller; any JBL product on which the serial number has been defaced, modified or removed.

Who Pays For What?

JBL will pay all labor and material expenses for all repairs covered by this warranty. Please be sure to save the original shipping cartons because a charge will be made if replacement cartons are requested. Payment of shipping charges is discussed in the next section of this warranty.

How To Obtain Warranty Performance

If your JBL product ever needs service, write or telephone us at JBL Incorporated (Attn: Customer Service Department), 8500 Balboa Boulevard, PO. Box 2200, Northridge, California 91329 (818/893-8411). We may direct you to an authorized JBL Service Agency or ask you to send your unit to the factory for repair. Either way, you'll need to present the original bill of sale to establish the date of purchase. Please do not ship your JBL product to the factory without prior authorization. If transportation of your JBL product presents any unusual difficulties, please advise us and we may make special arrangements with you. Otherwise, you are responsible for transporting your product for repair or arranging for its transportation and for payment of any initial shipping charges. However, we will pay the return shipping charges if repairs are covered by the warranty.

Limitation of Implied Warranties

ALL IMPLIED WARRANTIES, INCLUDING WARRANTIES OF MERCHANTABILITY AND FITNESS FOR PARTICULAR PURPOSE, ARE LIMITED IN DURATION TO THE LENGTH OF THIS WARRANTY.

EXCLUSION OF CERTAIN DAMAGES

JBL'S LIABILITY IS LIMITED TO THE REPAIR OR REPLACEMENT, AT OUR OPTION, OF ANY DEFECTIVE PRODUCT AND SHALL NOT INCLUDE INCIDENTAL OR CONSEQUENTIAL DAMAGES OF ANY KIND. SOME STATES DO NOT ALLOW LIMITATIONS ON HOW LONG AN IMPLIED WARRANTY LASTS AND/OR DO NOT ALLOW THE EXCLUSION OF INCIDENTAL OR CONSEQUENTIAL DAMAGES, SO THE ABOVE LIMITATIONS AND EXCLUSIONS MAY NOT APPLY TO YOU. THIS WARRANTY GIVES YOU SPECIFIC LEGAL RIGHTS, AND YOU MAY ALSO HAVE OTHER RIGHTS, WHICH VARY, FROM STATE TO STATE.

JBL Professional

8500 Balboa Blvd. Northridge, CA 91329 USA

EON ONE MK2